



**ResMed**

**AirSense™ 10**

AUTOSET

AUTOSET FOR HER

ELITE

PLUS



User guide  
English | 简体中文

## Welcome

The AirSense™ 10 AutoSet™ Plus and AirSense 10 AutoSet for Her Plus are ResMed's premium auto-adjusting pressure devices. The AirSense 10 Elite Plus is ResMed's Continuous Positive Airway Pressure (CPAP) devices.

### **WARNING**

- Read this entire guide before using the device.
- Use the device according to the intended use provided in this guide.
- The advice provided by your prescribing doctor should be followed ahead of the information provided in this guide.

## Indications for use

### **AirSense 10 AutoSet Plus**

The AirSense 10 AutoSet Plus self-adjusting device is indicated for the treatment of obstructive sleep apnoea (OSA) in patients weighing more than 30 kg. It is intended for home and hospital use.

The humidifier is intended for single patient use in the home environment and re-use in a hospital/institutional environment.

### **AirSense 10 AutoSet for Her Plus**

The AirSense 10 AutoSet for Her Plus self-adjusting device is indicated for the treatment of obstructive sleep apnoea (OSA) in female patients with mild to moderate OSA weighing more than 30 kg. It is intended for home and hospital use.

The humidifier is intended for single patient use in the home environment and re-use in a hospital/institutional environment.

### **AirSense 10 Elite Plus**

The AirSense 10 Elite Plus device is indicated for the treatment of obstructive sleep apnoea (OSA) in patients weighing more than 30 kg. It is intended for home and hospital use.

The humidifier is intended for single patient use in the home environment and re-use in a hospital/institutional environment.

## Contraindications

Positive airway pressure therapy may be contraindicated in some patients with the following pre-existing conditions:

- severe bullous lung disease
- pneumothorax
- pathologically low blood pressure
- dehydration
- cerebrospinal fluid leak, recent cranial surgery, or trauma.

## Adverse effects

You should report unusual chest pain, severe headache, or increased breathlessness to your prescribing physician. An acute upper respiratory tract infection may require temporary discontinuation of treatment.

The following side effects may arise during the course of therapy with the device:

- drying of the nose, mouth, or throat
- nosebleed
- bloating
- ear or sinus discomfort
- eye irritation
- skin rashes.

## At a glance

The AirSense 10 Plus includes the following:

- Device
- HumidAir™ humidifier
- Air tubing
- Power supply unit
- Travel bag
- SD card (already inserted).

Contact your care provider for a range of accessories available for use with the device including:

- Air tubing (heated and non-heated): ClimateLineAir™, SlimLine™, ClimateLineAir Oxy, Standard
- Side cover for use without the humidifier
- Filter: Hypoallergenic filter, standard filter
- Air10™ DC/DC converter
- SD card reader
- Air10 oximeter adapter
- Air10 USB adapter
- Power Station II
- Air10 tubing elbow.

## About your device

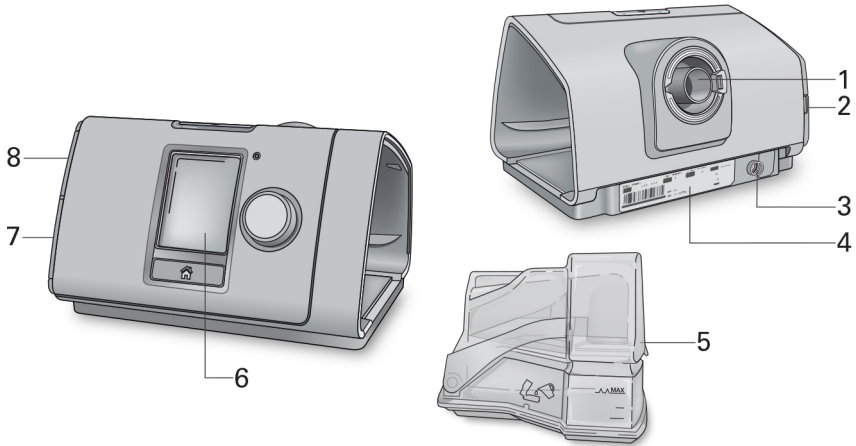

- 1 Air outlet
- 2 Air filter cover
- 3 Power inlet
- 4 Serial number and device number

- 5 HumidAir humidifier
- 6 Screen
- 7 Adapter cover
- 8 SD card cover

## About the control panel



Start/Stop button

Press to start/stop therapy.  
Press and hold for three seconds to enter power save mode.



Dial

Turn to navigate the menu and press to select an option.  
Turn to adjust a selected option and press to save your change.



Home button

Press to return to the Home screen.

Different icons may be displayed on the screen at different times including:



Ramp Time



Wireless signal strength (green)

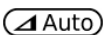

Ramp Time Auto



Wireless transfer not enabled (grey)



Humidity



No wireless connection



Humidifier warming



Airplane Mode



Humidifier cooling

## Setup

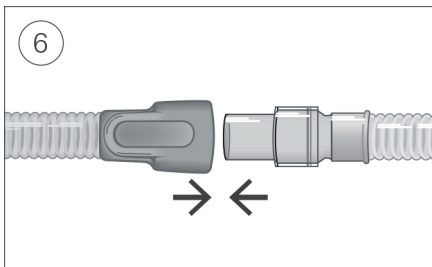
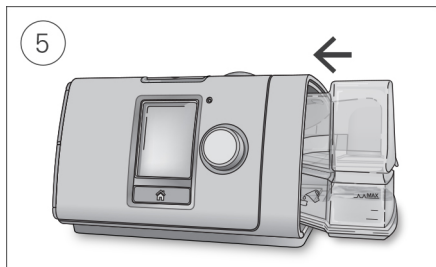
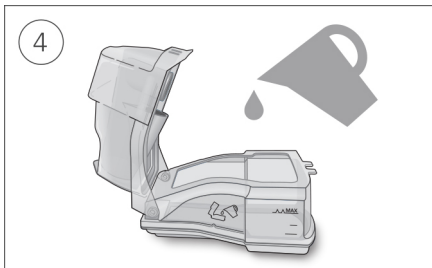
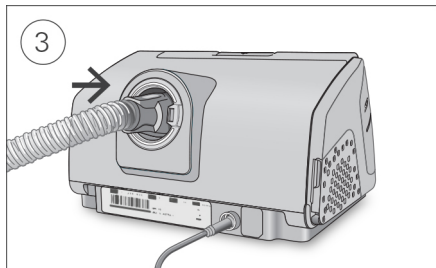
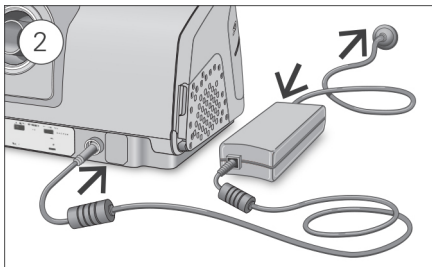
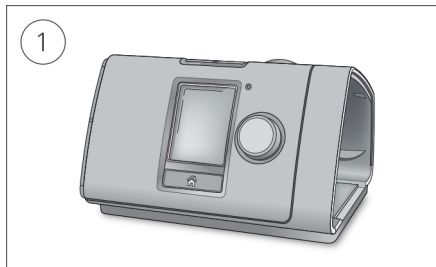

### CAUTION

Do not overfill the humidifier as water may enter the device and air tubing.

1. Place the device on a stable level surface.
2. Plug the power connector into the rear of the device. Connect one end of the power cord into the power supply unit and the other end into the power outlet.
3. Connect the air tubing firmly to the air outlet located on the rear of the device.
4. Open the humidifier and fill it with water up to the maximum water level mark. Do not fill the humidifier with hot water.
5. Close the humidifier and insert it into the side of the device.
6. Connect the free end of the air tubing firmly onto the assembled mask. See the mask user guide for detailed information.

Recommended masks are available on [www.resmed.com](http://www.resmed.com).

# Starting therapy

1. Fit your mask.
2. Press Start/Stop or breathe normally if SmartStart™ is enabled.

You will know that therapy is on when the **Sleep Report** screen is displayed.



The current treatment pressure is shown in green.

During ramp time the pressure is gradually increasing and you will see a spinning circle. Once the prescribed treatment pressure is reached, the entire circle will be green.

The screen will go black automatically after a short period of time. You can press Home or the dial to turn it back on. If power is interrupted during therapy, the device will automatically restart therapy when power is restored.

The AirSense 10 Plus device has a light sensor that adjusts the screen brightness based on the light in the room.

# Stopping therapy

1. Remove your mask.
2. Press Start/Stop or if SmartStart is enabled, therapy will stop automatically after a few seconds.

The **Sleep Report** now gives you a summary of your therapy session.



**Usage hours**—Indicates the number of hours of therapy you received last session.

**Mask Seal**—Indicates how well your mask sealed:

 Good mask seal.

 Needs adjusting, see Mask Fit.

**Humidifier**—Indicates if your humidifier is working properly:

 Humidifier working.

 Humidifier might be faulty, contact your care provider.

If set by your care provider, you will also see:

**Events per hour**—Indicates the number of apnoeas and hypopnoeas experienced per hour.

**More Info**—Turn the dial to scroll down to view more detailed usage data.

## Power save mode

Your AirSense 10 Plus device records your therapy data. In order to allow it to transmit the data to your care provider, you should not unplug the device. However, you can put it into power save mode to save electricity.

### To enter power save mode:

- Press and hold Start/Stop for three seconds.  
The screen goes black.

### To exit power save mode:

- Press Start/Stop once.  
The **Home** screen is displayed.

## My Options

Your AirSense 10 Plus device has been set up for your needs by your care provider, but you may find you want to make small adjustments to make your therapy more comfortable.

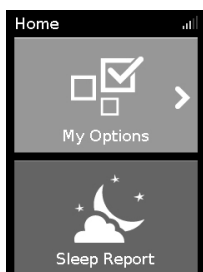

Highlight **My Options** and press the dial to see your current settings. From here, you can personalise your options.

## Ramp Time

Designed to make the beginning of therapy more comfortable, Ramp Time is the period during which the pressure increases from a low start pressure to the prescribed treatment pressure.

You can set your Ramp Time to Off, 5 to 45 minutes or Auto. When Ramp Time is set to **Auto**, the device will detect when you have fallen asleep and then automatically rise to the prescribed treatment pressure.



### To adjust Ramp Time:

1. In **My Options**, turn the dial to highlight **Ramp Time** and then press the dial.
2. Turn the dial to adjust the ramp time to your preferred setting and press the dial to save the change.

## Humidity Level

The humidifier moistens the air and is designed to make therapy more comfortable. If you are getting a dry nose or mouth, turn up the humidity. If you are getting any moisture in your mask, turn down the humidity.

You can set the Humidity Level to Off or between 1 and 8, where 1 is the lowest humidity setting and 8 is the highest humidity setting.

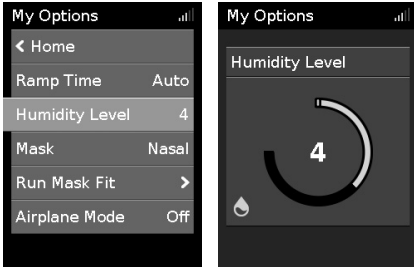

To adjust the Humidity Level:

1. In **My Options**, turn the dial to highlight **Humidity Level** and then press the dial.
2. Turn the dial to adjust the humidity level and press the dial to save the change.

If you continue to get a dry nose or mouth, or moisture in your mask, consider using ClimateLineAir heated air tubing. ClimateLineAir together with Climate Control delivers more comfortable therapy.

## Mask Fit

Mask Fit is designed to help you assess and identify possible air leaks around your mask.



To check Mask Fit:

1. Fit the mask as described in the mask user guide.
2. In **My Options**, turn the dial to highlight **Run Mask Fit** and then press the dial.  
The device starts blowing air.
3. Adjust the mask, mask cushion and headgear until you get a **Good** result.

To stop Mask Fit, press the dial or Start/Stop. If you are unable to get a good mask seal, talk to your care provider.

## More options

There are some more options on your device which you can personalise.

**Pressure Relief\*** When Pressure Relief is enabled, you may find it easier to breathe out. This can help you get used to therapy.

**SmartStart\*** When SmartStart is enabled, therapy starts automatically when you breathe into your mask. When you remove your mask, it stops automatically after a few seconds.

\*When enabled by your care provider.



## Caring for your device

It is important that you regularly clean your AirSense 10 Plus device to make sure you receive optimal therapy. The following sections will help you with disassembling, cleaning, checking and reassembling your device.

### WARNING

Regularly clean your tubing assembly, humidifier and mask to receive optimal therapy and to prevent the growth of germs that can adversely affect your health.

### Disassembling

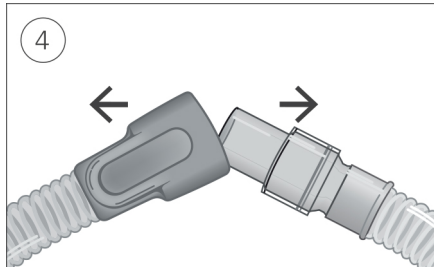
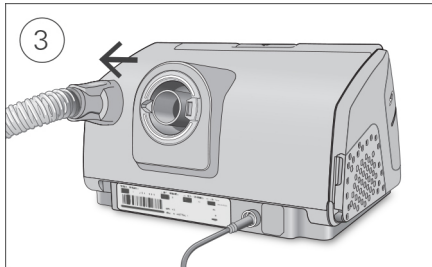
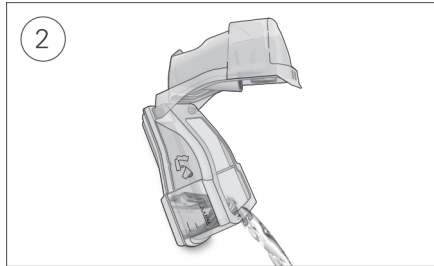
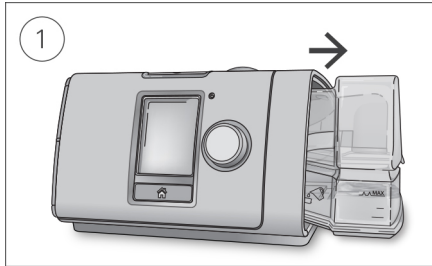

1. Hold the humidifier at the top and bottom, press it gently and pull it away from the device.
2. Open the humidifier and discard any remaining water.
3. Hold the cuff of the air tubing and gently pull it away from the device.
4. Hold both the cuff of the air tubing and the swivel of the mask, then gently pull apart.

### Cleaning

You should clean the device weekly as described. Refer to the mask user guide for detailed instructions on cleaning your mask.

1. Wash the humidifier and air tubing in warm water using mild detergent.
2. Rinse the humidifier and air tubing thoroughly and allow to dry out of direct sunlight and/or heat.
3. Wipe the exterior of the device with a dry cloth.

## Notes:

- The humidifier may be washed in a dishwasher on the delicate or glassware cycle (top shelf only). It should not be washed at temperatures higher than 65°C.
- Do not wash the air tubing in a dishwasher or washing machine.
- Empty the humidifier daily and wipe it thoroughly with a clean, disposable cloth. Allow to dry out of direct sunlight and/or heat.

## Checking

You should regularly check the humidifier, air tubing and the air filter for any damage.

1. Check the humidifier:
  - Replace it if it is leaking or has become cracked, cloudy or pitted.
  - Replace it if the seal is cracked or torn.
  - Remove any white powder deposits using a solution of one part household vinegar to 10 parts water.
2. Check the air tubing and replace it if there are any holes, tears or cracks.
3. Check the air filter and replace it at least every six months. Replace more often if there are any holes or blockages by dirt or dust.

### To replace the air filter:

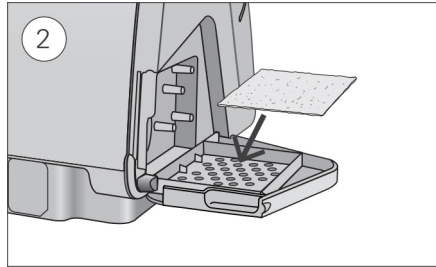
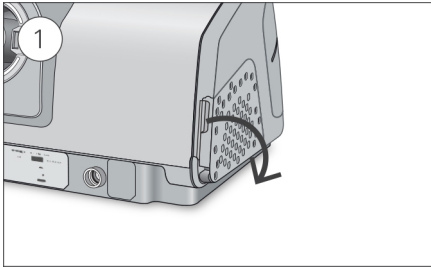

1. Open the air filter cover and remove the old air filter.  
The air filter is not washable or reusable.
2. Place a new air filter onto the air filter cover and then close it.  
Make sure the air filter is fitted at all times to prevent water and dust from entering the device.

## Reassembling

When the humidifier and air tubing are dry, you can reassemble the parts.

1. Connect the air tubing firmly to the air outlet located on the rear of the device.
2. Open the humidifier and fill it with room temperature water up to the maximum water level mark.
3. Close the humidifier and insert it into the side of the device.
4. Connect the free end of the air tubing firmly onto the assembled mask.

## Therapy data

Your AirSense 10 Plus device records your therapy data for you and your care provider so they can view and make changes to your therapy if required. The data is recorded and then transferred to your care provider via an SD card.

### SD card

An alternative way for your therapy data to be transferred to your care provider is via the SD card. Your care provider may ask you to send the SD card by mail or to bring it in. When instructed by your care provider, remove the SD card.

Do not remove the SD card from the device when the SD light is flashing.

### To remove the SD card:

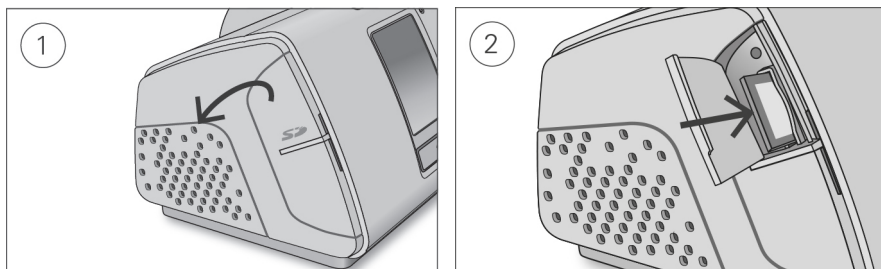

1. Open the SD card cover.
2. Push in the SD card to release it. Remove the SD card from the device.  
Place the SD card in the protective folder and send it back to your care provider.

For more information on the SD card refer to the SD card protective folder provided with your device.

**Note:** The SD card should not be used for any other purpose.

## Travelling

You can take your AirSense 10 Plus device with you wherever you go. Just keep the following in mind:

- Use the travel bag provided to prevent damage to the device.
- Empty the humidifier and pack it separately in the travel bag.
- Make sure you have the appropriate power cord for the region you are travelling to. For information on purchasing, contact your care provider.
- If you are using an external battery, you should turn off the humidifier in order to maximise the life of your battery. Do this by turning the **Humidity Level** to Off.

### Travelling by plane

Your AirSense 10 Plus device may be taken on board as carry-on luggage. Medical devices do not count toward your carry-on luggage limit.

You can use your AirSense 10 device on a plane as it meets the Federal Aviation Administration (FAA) requirements. Air travel compliance letters can be downloaded and printed from [www.resmed.com](http://www.resmed.com).

When using the device on a plane:

- Make sure the humidifier is completely empty and inserted into your device. The device will not work without the humidifier inserted.
- Turn on **Airplane Mode**.

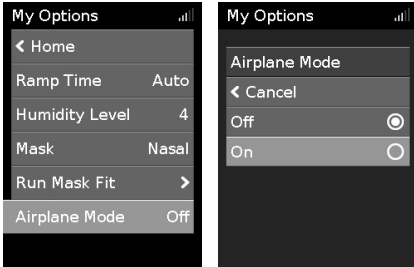

To turn on Airplane Mode:

1. In **My Options**, turn the dial to highlight **Airplane Mode** and then press the dial.
2. Turn the dial to select **On** and then press the dial to save the change.  
The Airplane Mode icon ✈️ is displayed at the top right of the screen.

## ⚠ CAUTION

Do not use the device with water in the humidifier on a plane due to the risk of inhalation of water during turbulence.

## Troubleshooting

If you have any problems, have a look at the following troubleshooting topics. If you are not able to fix the problem, contact your care provider or ResMed. Do not try to open the device.



### General troubleshooting

Problem/possible cause	Solution
<b>Air is leaking from around my mask</b> Mask may be fitted incorrectly.	Make sure your mask is fitted correctly. See your mask user guide for fitting instructions or use the Mask Fit function to check your mask fit and seal.
<b>I am getting a dry or blocked nose</b> Humidity level may be set too low.	Adjust the Humidity Level. If you have ClimateLineAir heated air tubing, see the ClimateLineAir user guide.
<b>I am getting droplets of water on my nose, in the mask and air tubing</b> Humidity level may be set too high.	Adjust the Humidity Level. If you have ClimateLineAir heated air tubing, see the ClimateLineAir user guide.
<b>My mouth is very dry and uncomfortable</b> Air may be escaping through your mouth.	Increase the Humidity Level. You may need a chin strap to keep your mouth closed or a full face mask.

<b>Problem/possible cause</b>	<b>Solution</b>
<b>Air pressure in my mask seems too high (it feels like I am getting too much air)</b>	
Ramp may be turned off.	Use the Ramp Time option.
<b>Air pressure in my mask seems too low (it feels like I am not getting enough air)</b>	
Ramp may be in progress.	Wait for air pressure to build up or turn Ramp Time off.
<b>My screen is black</b>	
Backlight on the screen may have turned off. It turns off automatically after a short period of time.	Press Home or the dial to turn it back on.
Power may not be connected.	Connect the power supply and make sure the plug is fully inserted.
<b>I have stopped therapy, but the device is still blowing air</b>	
Device is cooling down.	Device blows a small amount of air in order to avoid condensation in the air tubing. It will stop automatically after 30 minutes.
<b>My humidifier is leaking</b>	
Humidifier may not be assembled correctly.	Check for damage and reassemble the humidifier correctly.
Humidifier may be damaged or cracked.	Contact your care provider for a replacement.
<b>My screen and buttons are flashing</b>	
Software upgrade is in progress.	Software upgrade takes approximately 10 minutes to complete.

## Device messages

<b>Device message/possible cause</b>	<b>Solution</b>
<b>High leak detected, check your water tub, tub seal or side cover</b>	
Humidifier may not be inserted properly.	Make sure the humidifier is correctly inserted.
Humidifier seal may not be inserted properly.	Open the humidifier and make sure that the seal is correctly inserted.
<b>High leak detected, connect your tubing</b>	
Air tubing may not be connected properly.	Make sure the air tubing is firmly connected at both ends.
Mask may be fitted incorrectly.	Make sure your mask is fitted correctly. See your mask user guide for fitting instructions or use the Mask Fit function to check your mask fit and seal.

Device message/possible cause	Solution
<b>Tubing blocked, check your tubing</b>	
Air tubing may be blocked.	Check the air tubing and remove any blockages. Press the dial to clear the message and then press Start/Stop to restart the device.
<b>SD card error, remove your card and press Start to begin therapy</b>	
SD card may not be inserted correctly.	Remove and reinsert the SD card.
<b>Read only card, please remove, unlock and re-insert SD card</b>	
SD card switch may be in the lock (read-only) position.	Move the switch on the SD Card from the lock position  to the unlock position  and then re-insert it.
<b>System fault, refer to user guide, Error 004</b>	
Device may have been left in a hot environment.	Allow to cool before re-use. Disconnect the power supply and then reconnect it to restart the device.
Air filter may be blocked.	Check the air filter and replace it if there are any blockages. Disconnect the power supply and then reconnect it to restart the device.
Air tubing may be blocked.	Check the air tubing and remove any blockages. Press the dial to clear the message and then press Start/Stop to restart the device.
There may be water in the air tubing.	Empty the water from the air tubing. Disconnect the power supply and then reconnect it to restart the device.
<b>All other error messages, for example, System fault, refer to user guide, Error 0XX</b>	
An unrecoverable error has occurred on the device.	Contact your care provider. Do not open the device.

## Reassembling parts

Some parts of your device are designed to easily come off in order to avoid damage to the parts or the device. You can easily reassemble them as described below.

### To insert the humidifier seal:

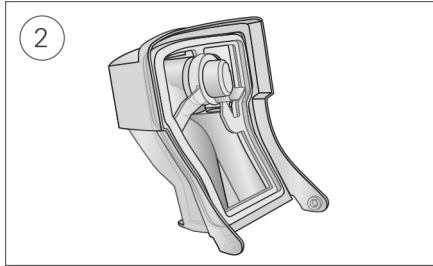
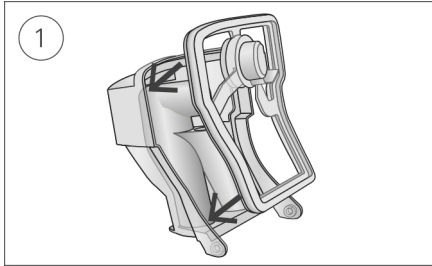

1. Place the seal into the lid.
2. Press down along all edges of the seal until it is firmly in place.

### To reassemble the humidifier lid:

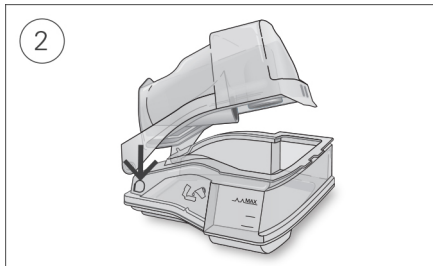
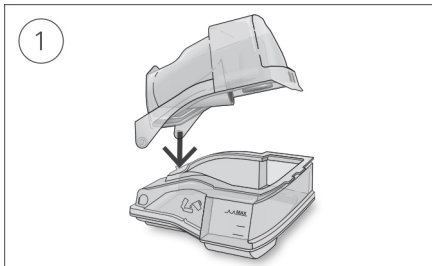

1. Insert one side of the lid into the pivot hole of the base.
2. Slide the other side down the ridge until it clicks into place.

## WARNING

- Make sure that you arrange the air tubing so that it will not twist around the head or neck.
- Make sure the power cord and plug are in good condition and the equipment is not damaged.
- Keep the power cord away from hot surfaces.
- If you notice any unexplained changes in the performance of the device, if it is making unusual sounds, if the device or the power supply are dropped or mishandled, or if the enclosure is broken, discontinue use and contact your care provider or your ResMed Service Centre.
- Do not open or modify the device. There are no user serviceable parts inside. Repairs and servicing should only be performed by an authorised ResMed service agent.
- Beware of electrocution. Do not immerse the device, power supply or power cord in water. If liquids are spilled into or onto the device, unplug the device and let the parts dry. Always unplug the device before cleaning and make sure that all parts are dry before plugging it back in.
- Supplemental oxygen must not be used while smoking or in the presence of an open flame.
- Always make sure that the device is turned on and airflow generated before the oxygen supply is turned on. Always turn the oxygen supply off before the device is turned off, so that unused oxygen does not accumulate within the device enclosure and create a risk of fire.
- Do not perform any maintenance tasks while the device is in operation.
- The device should not be used adjacent to or stacked with other equipment. If adjacent or stacked use is necessary, the device should be observed to verify normal operation in the configuration in which it will be used.
- The use of accessories other than those specified for the device is not recommended. They may result in increased emissions or decreased immunity of the device.
- Regularly check the antibacterial filter for signs of moisture or other contaminants, particularly during nebulization or humidification. Failure to do so could result in increased breathing system resistance.

## CAUTION

- Use only ResMed parts and accessories with the device. Non-ResMed parts may reduce the effectiveness of the treatment and/or damage the device.
- Use only vented masks recommended by ResMed or by the prescribing doctor with this device. Fitting the mask without the device blowing air can result in rebreathing of exhaled air. Make sure that the mask vent holes are kept clear and unblocked to maintain the flow of the fresh air into the mask.
- Be careful not to place the device where it can be bumped or where someone is likely to trip over the power cord.
- Blocking the air tubing and/or air inlet of the device while in operation could lead to overheating of the device.
- Keep the area around the device dry, clean and clear of anything (eg, clothes or bedding) that could block the air inlet or cover the power supply unit.
- Do not place the device on its side as water might get into the device.
- Incorrect system setup may result in incorrect mask pressure reading. Ensure the system is correctly set up.



- Do not use bleach, chlorine, alcohol, or aromatic-based solutions, moisturising or antibacterial soaps or scented oils to clean the device, the humidifier or air tubing. These solutions may cause damage or affect the humidifier performance and reduce the life of the products.
- If you use the humidifier, always place the device on a level surface lower than your head to prevent the mask and air tubing from filling with water.
- Leave the humidifier to cool for ten minutes before handling to allow the water to cool and to make sure that the humidifier is not too hot to touch.
- Make sure that the humidifier is empty before transporting the device.

## Technical specifications

Units are expressed in cm H<sub>2</sub>O and hPa. 1 cm H<sub>2</sub>O is equal to 0.98 hPa.

### 90W power supply unit

AC input range:	100–240V, 50–60Hz 1.0–1.5A, Class II 115V, 400Hz 1.5A, Class II (nominal for aircraft use)
DC output:	24V  3.75A
Typical power consumption:	53W (57VA)
Peak power consumption:	104W (108VA)

### Environmental conditions

Operating temperature:	+5°C to +35°C <b>Note:</b> The air flow for breathing produced by this therapy device can be higher than the temperature of the room. Under extreme ambient temperature conditions (40°C) the device remains safe.
Operating humidity:	10 to 95% relative humidity, non-condensing
Operating altitude:	Sea level to 2,591 m; air pressure range 1013 hPa to 738 hPa
Storage and transport temperature:	-20°C to +60°C
Storage and transport humidity:	5 to 95% relative humidity, non-condensing

### Electromagnetic compatibility

The AirSense 10 complies with all applicable electromagnetic compatibility requirements (EMC) according to IEC 60601-1-2:2014, for residential, commercial and light industry environments. It is recommended that mobile communication devices are kept at least 1 m away from the device.

Information regarding the electromagnetic emissions and immunity of this ResMed device can be found on [www.resmed.com/downloads/devices](http://www.resmed.com/downloads/devices)

### Classification: IEC 60601-1:2005+A1:2012

Class II (double insulation), Type BF, Ingress protection IP22.

### Sensors

Pressure sensor:	Internally located at device outlet, analogue gauge pressure type, -5 to +45 cm H <sub>2</sub> O (-5 to +45 hPa)
Flow sensor:	Internally located at device inlet, digital mass flow type, -70 to +180 L/min

### Maximum single fault steady pressure

Device will shut down in the presence of a single fault if the steady state pressure exceeds:  
30 cm H<sub>2</sub>O (30 hPa) for more than 6 sec or 40 cm H<sub>2</sub>O (40 hPa) for more than 1 sec.

## Sound

Pressure level measured according to ISO 80601-2-70:2015 (CPAP mode):

SlimLine: 25 dBA with uncertainty of 2 dBA

Standard: 25 dBA with uncertainty of 2 dBA

SlimLine or Standard and humidification: 27 dBA with uncertainty of 2 dBA

Power level measured according to ISO 80601-2-70:2015 (CPAP mode):

SlimLine: 33 dBA with uncertainty of 2 dBA

Standard: 33 dBA with uncertainty of 2 dBA

SlimLine or Standard and humidification: 35 dBA with uncertainty of 2 dBA

Declared dual-number noise emission values in accordance with ISO 4871:1996.

---

## Physical - device and humidifier

Dimensions (H x W x D): 116 mm x 255 mm x 150 mm

Air outlet (complies with ISO 5356-1:2004): 22 mm

Weight (device and cleanable humidifier): 1208 g

Housing construction: Flame retardant engineering thermoplastic

Water capacity: To maximum fill line 380 mL

Cleanable humidifier - material: Injection moulded plastic, stainless steel and silicone seal

---

## Temperature

Maximum heater plate: 68°C

Cut-out: 74°C

Maximum gas temperature: ≤ 41°C

---

## Air filter

Standard: Material: Polyester non woven fibre  
Average arrestance: >75% for ~7 micron dust

Hypoallergenic: Material: Acrylic and polypropylene fibres in a polypropylene carrier  
Efficiency: >98% for ~7-8 micron dust; >80% for ~0.5 micron dust

---

## Aircraft use

ResMed confirms that device meets the Federal Aviation Administration (FAA) requirements (RTCA/DO-160, section 21, category M) for all phases of air travel.

---

## Declaration of Conformity (DoC to the R&TTE Directive)

ResMed declares that the AirSense 10 Plus device is in compliance with the essential requirements and other relevant provisions of Directive 1999/5/EC. A copy of the declaration of conformity (DoC) can be found on [www.ResMed.com/ProductSupport](http://www.ResMed.com/ProductSupport).

---

## Operating pressure range

AutoSet, AutoSet For Her, CPAP: 4 to 20 cm H<sub>2</sub>O (4 to 20 hPa)

---

## Supplemental oxygen

Maximum flow: 4 L/min

---

## Pneumatic flow path

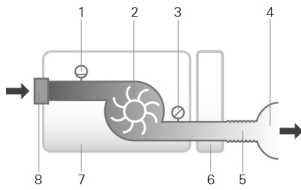

1. Flow sensor
2. Blower
3. Pressure sensor
4. Mask
5. Air tubing
6. Humidifier
7. Device
8. Inlet filter

## Design life

Device, power supply unit:	5 years
Cleanable humidifier:	2.5 years
Air tubing:	6 months

## General

The patient is an intended operator.

## Humidifier performance

Mask Pressure cm H <sub>2</sub> O (hPa)	RH output % at 17°C ambient temperature	RH output % at 22°C ambient temperature	Nominal system output AH <sup>1</sup> , BTPS <sup>2</sup>	
	Setting 4	Setting 8	Setting 4	Setting 8
4	85	100	6	>10
10	85	100	6	>10
20	85	90	6	>10

<sup>1</sup> AH - Absolute Humidity in mg/L

<sup>2</sup> BTPS - Body Temperature Pressure Saturated

## Air tubing

Air tubing	Material	Length	Inner diameter
ClimateLineAir	Flexible plastic and electrical components	2 m	15 mm
ClimateLineAir Oxy	Flexible plastic and electrical components	1.9 m	19 mm
SlimLine	Flexible plastic	1.8 m	15 mm
Standard	Flexible plastic	2 m	19 mm

Heated air tubing temperature cut-out: ≤ 41°C

## Notes:

- The manufacturer reserves the right to change these specifications without notice.
- The electrical connector end of the heated air tubing is only compatible with the air outlet at the device end and should not be fitted to the mask.
- Do not use electrically conductive or antistatic air tubing.
- The temperature and relative humidity settings displayed are not measured values.

## Displayed values

Value	Range	Display resolution
Pressure sensor at air outlet:		
Mask pressure	4–20 cm H <sub>2</sub> O (4–20 hPa)	0.1 cm H <sub>2</sub> O (0.1 hPa)
Flow derived values:		
Leak	0–120 L/min	1 L/min

Value	Accuracy
Pressure measurement <sup>1</sup> :	
Mask pressure <sup>2</sup>	±[0.5 cm H <sub>2</sub> O (0.5 hPa) + 4% of measured value]
Flow and flow derived values <sup>1</sup> :	
Flow	±6 L/min or 10% of reading, whichever is greater, at 0 to 150 L/min positive flow
Leak <sup>2</sup>	±12 L/min or 20% of reading, whichever is greater, 0 to 60 L/min

<sup>1</sup> Results are expressed as STPD (Standard Temperature and Pressure, Dry).

<sup>2</sup> Accuracy may be reduced by the presence of leaks, supplemental oxygen, tidal volumes <100 mL or minute ventilation <3 L/min.

## Measurement system uncertainties

In accordance with ISO 80601-2-70:2015 the measurement uncertainty of the manufacturer's test equipment is:

For measures of flow	± 1.5 L/min or ± 2.7% of reading (whichever is greater)
For measures of volume (< 100 mL)	± 5 mL or 6% of reading (whichever is greater)
For measures of volume (≥ 100 mL)	± 20 mL or 3% of reading (whichever is greater)
For measures of pressure	± 0.15 cm H <sub>2</sub> O (0.15 hPa)
For measures of time	± 10 ms

## Pressure accuracy

### Maximum static pressure variation at 10 cm H<sub>2</sub>O (10 hPa) according to ISO 80601-2-70:2015

	Standard air tubing	SlimLine air tubing
Without humidification	± 0.5 cm H <sub>2</sub> O (± 0.5 hPa)	± 0.5 cm H <sub>2</sub> O (± 0.5 hPa)
With humidification	± 0.5 cm H <sub>2</sub> O (± 0.5 hPa)	± 0.5 cm H <sub>2</sub> O (± 0.5 hPa)

### Maximum dynamic pressure variation according to ISO 80601-2-70:2015

Device without humidification and Standard air tubing / Device with humidification and Standard air tubing			
Pressure [cm H <sub>2</sub> O (hPa)]	10 BPM	15 BPM	20 BPM
4	0.5 / 0.5	0.5 / 0.5	0.8 / 0.8
8	0.5 / 0.5	0.5 / 0.5	0.8 / 0.8
12	0.5 / 0.5	0.5 / 0.5	0.8 / 0.8
16	0.5 / 0.5	0.5 / 0.5	0.8 / 0.8
20	0.5 / 0.5	0.5 / 0.5	0.8 / 0.8
Device without humidification and SlimLine air tubing / Device with humidification and SlimLine air tubing			
Pressure [cm H <sub>2</sub> O (hPa)]	10 BPM	15 BPM	20 BPM
4	0.5 / 0.5	0.5 / 0.5	0.8 / 0.8
8	0.5 / 0.5	0.5 / 0.5	0.8 / 0.8
12	0.5 / 0.5	0.5 / 0.5	0.8 / 0.8
16	0.5 / 0.5	0.5 / 0.5	0.8 / 0.8
20	0.5 / 0.5	0.5 / 0.5	0.8 / 0.8

























## Flow (maximum) at set pressures

The following are measured accordingly to ISO 80601-2-70:2015 at the end of the specified air tubing:

Pressure	AirSense 10 Plus and Standard	AirSense 10 Plus, humidification and Standard	AirSense 10 Plus and SlimLine	AirSense 10 Plus, humidification and ClimateLineAir
cm H <sub>2</sub> O (hPa)	L/min	L/min	L/min	L/min
4	180	143	162	151
8	168	135	151	142
12	157	136	140	135
16	144	134	128	121
20	131	123	117	109

## Symbols

The following symbols may appear on the product or packaging.

 Read instructions before use.  Indicates a warning or caution.  Follow instructions before use.  Manufacturer.  European Authorised Representative.  Batch code.  Catalogue number.  Serial number.  Device number.  On / Off.  Device weight.  Protected against finger sized objects and against dripping water when tilted up to 15 degrees from specified orientation.  Direct current.  Type BF applied part.  Class II equipment.  Humidity limitation.  Temperature limitation.  Non-ionising radiation.  Contains no China environmental hazardous substances.  10/20 years of China environmental protection use period. **Rx Only** Prescription only (In the US, Federal law restricts these devices to sale by or on the order of a physician).  Maximum water level.  Use distilled water only.  Operating altitude.  Atmospheric pressure limitation.  Complies with RTCA DO-160 section 21, category M.



### Environmental information

This device should be disposed of separately, not as unsorted municipal waste. To dispose of your device, you should use appropriate collection, reuse and recycling systems available in your region. The use of these collection, reuse and recycling systems is designed to reduce pressure on natural resources and prevent hazardous substances from damaging the environment.

If you need information on these disposal systems, please contact your local waste administration. The crossed-bin symbol invites you to use these disposal systems. If you require information on collection and disposal of your ResMed device please contact your ResMed office, local distributor or go to [ResMed.com/environment](http://ResMed.com/environment).

## Serviceing

The AirSense 10 Plus device is intended to provide safe and reliable operation when operated in accordance with the instructions provided by ResMed. ResMed recommends that the AirSense 10 Plus device be inspected and serviced by an authorised ResMed Service Centre if there is any sign of wear or concern with device function. Otherwise, service and inspection of the products generally should not be required during their design life.

## Limited warranty

ResMed Pty Ltd (hereafter 'ResMed') warrants that your ResMed product shall be free from defects in material and workmanship from the date of purchase for the period specified below.

Product	Warranty period
<ul style="list-style-type: none"><li>• Mask systems (including mask frame, cushion, headgear and tubing)—excluding single-use devices</li><li>• Accessories—excluding single-use devices</li><li>• Flex-type finger pulse sensors</li><li>• Humidifier water tubs</li></ul>	90 days
<ul style="list-style-type: none"><li>• Batteries for use in ResMed internal and external battery systems</li></ul>	6 months
<ul style="list-style-type: none"><li>• Clip-type finger pulse sensors</li><li>• CPAP and bilevel device data modules</li><li>• Oximeters and CPAP and bilevel device oximeter adapters</li><li>• Humidifiers and humidifier cleanable water tubs</li><li>• Titration control devices</li></ul>	1 year
<ul style="list-style-type: none"><li>• CPAP, bilevel and ventilation devices (including external power supply units)</li><li>• Battery accessories</li><li>• Portable diagnostic/screening devices</li></ul>	2 years

This warranty is only available to the initial consumer. It is not transferable.

If the product fails under conditions of normal use, ResMed will repair or replace, at its option, the defective product or any of its components.

This Limited Warranty does not cover: a) any damage caused as a result of improper use, abuse, modification or alteration of the product; b) repairs carried out by any service organisation that has not been expressly authorised by ResMed to perform such repairs; c) any damage or contamination due to cigarette, pipe, cigar or other smoke; and d) any damage caused by water being spilled on or into an electronic device.

Warranty is void on product sold, or resold, outside the region of original purchase.

Warranty claims on defective product must be made by the initial consumer at the point of purchase.

This warranty replaces all other expressed or implied warranties, including any implied warranty of merchantability or fitness for a particular purpose. Some regions or states do not allow limitations on how long an implied warranty lasts, so the above limitation may not apply to you.

ResMed shall not be responsible for any incidental or consequential damages claimed to have resulted from the sale, installation or use of any ResMed product. Some regions or states do not allow the exclusion or limitation of incidental or consequential damages, so the above limitation may not apply to you.

This warranty gives you specific legal rights, and you may also have other rights which vary from region to region. For further information on your warranty rights, contact your local ResMed dealer or ResMed office.

## Further information

If you have any questions or require additional information on how to use the device, contact your care provider.

## 欢迎

AirSense™ 10 AutoSet™ Plus 和 AirSense 10 AutoSet for Her Plus 为 ResMed 的高级自动调整式压力装置。AirSense 10 Elite Plus 是 ResMed 的持续气道正压通气 (CPAP) 装置。

### 警告

- 使用装置前，请阅读此指南内所有内容。
- 根据本指南中提供的预期用途使用装置。
- 相比本指南中提供信息，由主治医师提供的建议应该优先服从。

## 使用指示

### **AirSense 10 AutoSet Plus**

AirSense 10 AutoSet Plus 自调式装置适用于治疗体重在 30kg 以上患者的阻塞性睡眠呼吸暂停 (OSA)。它适合在家中和医院使用。

增湿器用于在家中供一名患者使用，在医院/机构中可重复使用。

### **AirSense 10 AutoSet for Her Plus**

AirSense 10 AutoSet for Her Plus 自调式装置适用于治疗体重在 30 kg 以上女性患者的轻到中度阻塞性睡眠呼吸暂停 (OSA)。它适合在家中和医院中使用。

增湿器用于在家中供一名患者使用，在医院/机构中可重复使用。

### **AirSense 10 Elite Plus**

AirSense 10 Elite Plus 装置适用于治疗体重在 30kg 以上的患者的阻塞性睡眠呼吸暂停 (OSA)。它适合在家中和医院中使用。

增湿器用于在家中供一名患者使用，在医院/机构中可重复使用。

## 禁忌症

患有以下已有病症的患者，可能要禁用呼吸道正压通气疗法：

- 严重肺大泡性疾病
- 气胸
- 病理性低血压
- 脱水
- 脑脊液外漏、最近接受过开颅手术或外伤。

## 不良反应

若出现异常胸痛、严重头痛或呼吸困难程度增加，须告知您的经治医生。出现急性上呼吸道感染时，可能需要暂时中止治疗。

以此装置实施治疗时，可能会出现以下副作用：

- 口鼻或喉咙干燥
- 鼻衄
- 腹胀
- 耳部或鼻窦不适
- 眼部刺激
- 皮疹。

## 简介

AirSense 10 Plus 包括下列：

- 装置
- HumidAir™ 增湿器
- 空气管线
- 电源装置
- 旅行包
- SD 插卡（已经插入）。

联系您的保健服务提供商以了解一系列可用于装置的附件，包括：

- 空气管线（加热和未加热的）：ClimateLineAir™、SlimLine™、ClimateLineAir Oxy、标准
- 不与湿化器配套使用的侧盖
- 过滤器：低过敏原性过滤器、标准过滤器
- Air10™ 直流/直流转换器
- SD 卡读卡器
- Air10 血氧仪适配器
- Air10 USB 适配器
- Power Station II
- Air10 管路弯头。



## 关于您的装置

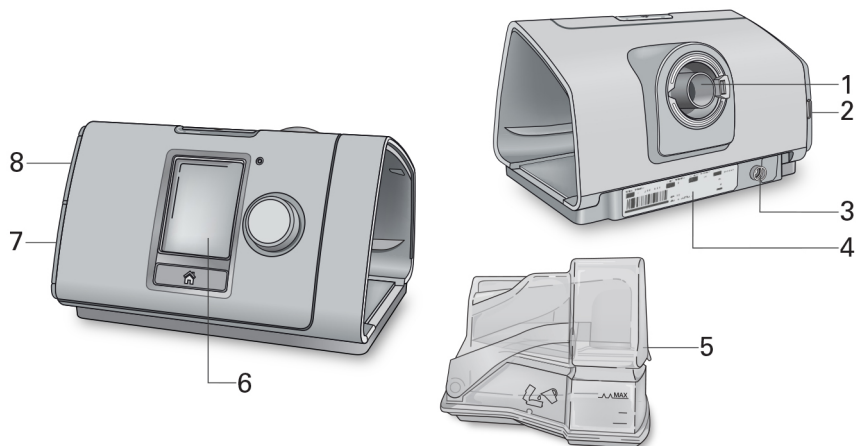

- 1 空气输出口
- 2 空气过滤器盖
- 3 电源线插口
- 4 序列号和装置号

- 5 HumidAir 增湿器
- 6 屏幕
- 7 适配器盖
- 8 SD 插卡盖

## 关于控制面板

 开始/停止按钮

按下以开始/停止治疗。  
按下并按住 3 秒以进入省电模式。

 微调器

找到导航菜单，按下以选择一个选项。  
旋转以调节已选定的选项，然后按下以保存更改。

 首页按钮

按下以返回到首页屏幕。

不同时间里屏幕上可能会显示不同的图标，包括：

 升压时间

 无线信号强度（绿色）

 升压时间自动

 未启用无线传输（灰色）

 湿度

 没有无线连接

 增湿器加温

 飞行模式

 增湿器冷却

## 设置

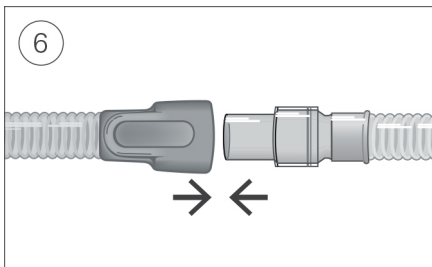
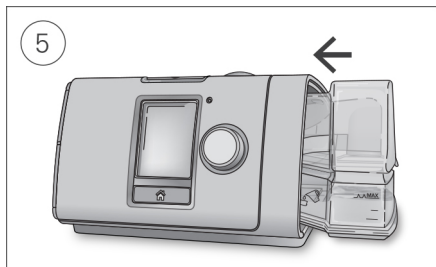
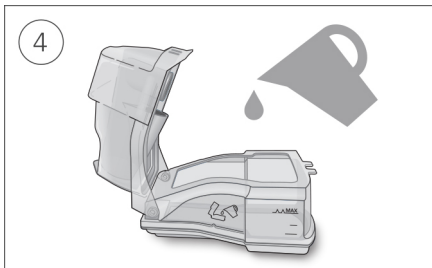
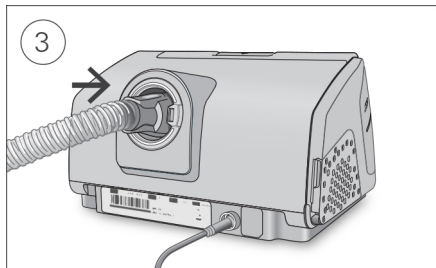
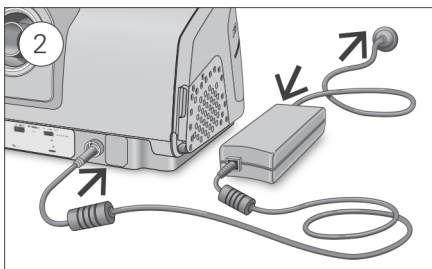
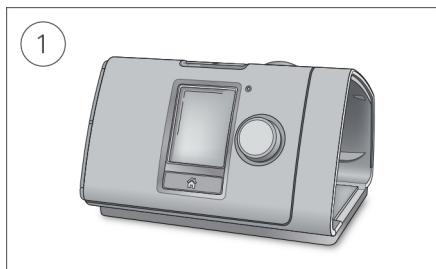

### ⚠注意

不得在加湿器中添加过多的水，以免水进入装置和空气管线。

1. 把装置放在稳定的水平面上。
2. 将电源接头插入装置后面。 连接电源线的一头到电源装置，另一头至电源插座。
3. 将空气管线牢固地连接至位于装置后面的空气输出口。
4. 打开加湿器并将水添加到最大水位线标志处。  
不得将热水装入加湿器。
5. 关闭加湿器并将其插入到装置的一侧。
6. 将空气管线的自由端牢固地连接到组装好的面罩系统。  
参阅面罩用户指南中的详细信息。

推荐的面罩可在 [www.resmed.com](http://www.resmed.com) 网站上找到。

## 开始治疗

1. 佩戴您的面罩。
2. 如果已启用智能启动，按下开始/停止按钮或正常呼吸。

当睡眠报告屏幕显示时，您就会知道治疗正在进行。



当前的治疗压力是绿色显示的。

在延迟升压时间内，压力是逐渐增加的，并且您将会看到一个旋转的环。一旦达到规定的治疗压力，整个环就会变绿。

很短一段时间后会自动黑屏。您可以按下首页或微调器将屏幕重新打开。如果治疗期间电源中断，恢复供电时，装置将自动重新启动治疗。

AirSense 10 Plus 装置有一个光传感器，它会根据室内光线调节屏幕亮度。

## 停止治疗

1. 取下您的面罩。
2. 按下开始/停止按钮，或者如果已启用智能启动，治疗会在几秒钟后自动停止。

睡眠报告总结您的治疗会话。



使用时间-指示上一次接受治疗的小时数。

面罩密封-显示面罩的密封程度：

😊 面罩密封良好。

☹️ 需要调整，请参阅面罩试戴。

增湿器-指示您的增湿器正常工作。

😊 增湿器正常工作。

☹️ 增湿器可能会出现故障，联系您的保健服务提供商。

如果由您的保健服务提供商设置，您将会看到：

每小时事件-指示每小时呼吸暂停和呼吸浅慢经历的次数。

更多信息-旋转微调器向下滚动来查看更多使用时间数据细节。

## 省电模式

AirSense 10 Plus 装置记录您的治疗数据。为了使装置能够向您的保健服务提供商传输数据，切勿拔下装置的电源插头。但您可以将装置置于省电模式以省电。

要进入省电模式：

- 按下开始/停止按钮并按住三秒钟。  
屏幕变黑。

要退出省电模式：

- 按下开始/停止按钮一次。  
首页屏幕显示。

## 我的选项

您的 AirSense 10 Plus 装置应该已由您的保健服务提供商按您的需要设置完毕，但是您可能会发现您需要稍作调整以使您的治疗更加舒适。



加亮 我的选项 并且按下微调器查看当前设定。从这里，您可以对您的选项进行个性化设置。

## 延迟升压时间

延迟升压时间功能是为了治疗开始时感到更舒适而设计的，这期间是压力从低的开始压力至指定的治疗压力。

您可以将您的升压时间设定为关、5 到 45 分钟，或者自动。升压时间设定为自动时，装置会检测到您已入睡，然后自动升至医生处方确定的治疗压力。



调整延迟升压时间：

1. 在 我的选项 界面，旋转微调器至升压时间变亮，然后按下微调器。
2. 旋转微调器将延迟升压时间调至您想要设定的值，然后按下微调器保存更改。

## 湿度水平

增湿器将空气雾化从而设计使治疗更加舒适。如果您感到口鼻干燥，开大湿度。如果您感到面罩内有任何湿气，关小湿度。

您可以将湿度水平设定为关闭或 1 和 8 之间，其中 1 为最低湿度设置，8 是最高湿度设置。



调节湿度水平：

1. 在 我的选项界面，旋转微调器至湿度水平变亮，然后按下微调器。
2. 旋转微调器调节湿度水平，然后按下微调器保存更改。

如果仍然感觉到您的面罩干燥或潮湿，考虑使用 ClimateLineAir 加热空气管线。ClimateLineAir 连同温度控制会给予更舒适的治疗。

## 面罩试戴

面罩试戴旨在帮助您评估并确定面罩周围是否可能漏气。



检查面罩试戴：

1. 按照面罩用户指南戴上面罩。
2. 在 我的选项界面，旋转微调器至运行面罩试戴变亮，然后按下微调器。装置开始输送气体。
3. 调整面罩、面罩护垫和头带，直到显示良好结果为止。

要停止面罩试戴，按下微调器或开始/停止按钮。如果无法获得良好的面罩密封，请致电保健服务提供商。

## 更多选项

您的设备上还有更多可以个性化设定的选项。

压力释放\* 启动压力释放后，您会发现更容易呼气。这可以帮助您适应治疗。

SmartStart（智能启动）\* 智能启动启动后，当您在面罩内呼气时，治疗会自动开始。当您取下面罩后，它会在几秒钟后自动停止。

\*在您的保健服务提供商启用了的情况下。

## 维护您的装置

定期清洁您的 AirSense 10 Plus 装置对确保您获得优化的治疗是十分重要的。以下的部分将会帮助您拆卸、清洁、检查和重新组装您的装置。

### 警告

定期清洁管路套组、加湿器和面罩，以获得最佳治疗，并防止细菌滋生，细菌滋生可能会对您的健康造成不良影响。

### 拆卸

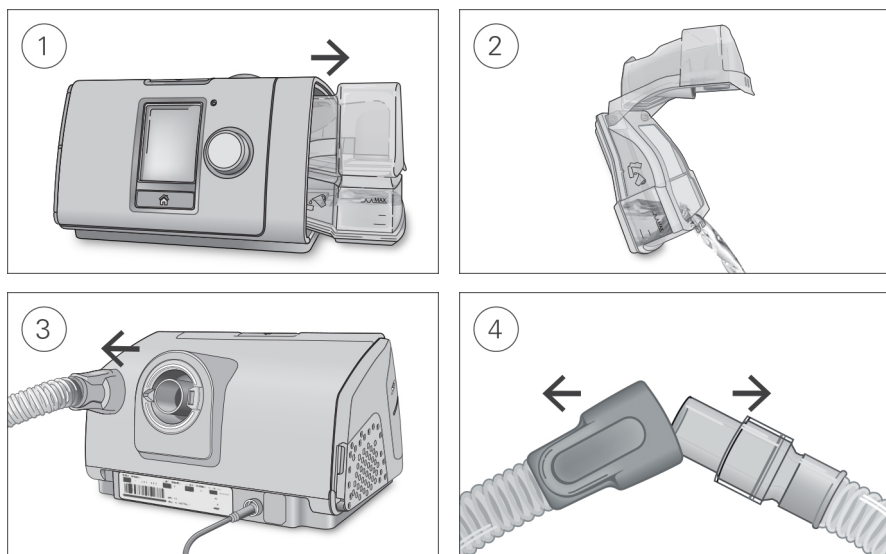

1. 抓住加湿器的上部和底部，轻轻地按压并从装置上拉出。
2. 打开加湿器并倒掉任何残余的水。
3. 抓住空气管线的接口并轻轻地将其从装置上拉开。
4. 同时抓住空气管线的接口和面罩的转环，然后轻轻地拉开。

### 清洁

如前所述您应该每周都清洁装置。参阅面罩用户指南关于清洁您面罩的细节信息。

1. 用含有柔和洗涤剂的温水清洗加湿器和空气管线。
2. 彻底冲洗加湿器和空气管线，自然晾干，避免阳光直射/或高温。
3. 用干布擦拭装置外部。

备注：

- 加湿器可以在洗碗机中以轻柔或用于玻璃器皿的周期清洗(仅可放在顶架)。清洗温度不应高于 65°C。
- 不得在洗碗机或洗衣机中清洗呼吸管路。
- 每天排空加湿器，并用一次性使用的洁净的布彻底擦拭。自然晾干，避免阳光直射和/或高温。

## 检查

您需要定期检查增湿器、空气管线和空气过滤器是否有任何损坏。

### 1. 检查增湿器:

- 若出现漏水或裂纹、混浊或凹痕，请更换。
- 如果密封条出现裂纹或撕裂，请更换。
- 用一份食醋兑 10 份水的溶液去除任何白色水垢。

### 2. 检查空气管线，若有任何破洞、撕裂或裂纹，请更换。

### 3. 至少每 6 个月检查并更换一次空气过滤器。如果有破洞或因污垢、灰尘造成的堵塞，请更经常更换。

更换空气过滤器:

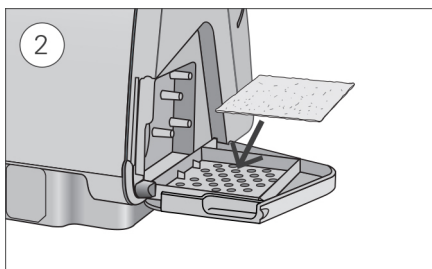
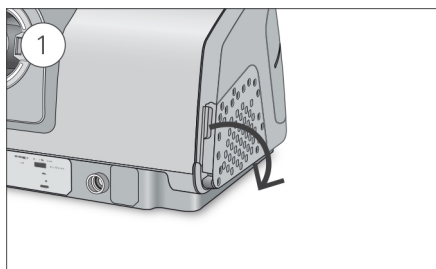

### 1. 打开空气过滤器盖并取下旧的空气过滤器。

空气过滤器不可清洗，也不可重复使用。

### 2. 将新的空气过滤器放在空气过滤器盖上，然后关上它。

确保空气过滤器一直安装以防止水和灰尘进入装置。

## 重新组装

增湿器和空气管线干燥后，就可以重新组装部件。

1. 将空气管线牢固地连接至位于装置后面的空气输出口。
2. 打开增湿器，将室温下的蒸馏水装至最高水位线标志处。
3. 关闭增湿器并将其插入到装置的一侧。
4. 将空气管线的自由端牢固地连接到组装好的面罩系统。

## 治疗数据

AirSense 10 Plus 装置为您和您的保健服务提供商记录您的治疗数据，以便他们需要时查看并且对您的治疗做出变动。数据被记录，然后通过 SD 卡传输给您的保健服务提供商。

### SD 插卡

另一种传输您的治疗数据的方式就是通过 SD 插卡。您的保健服务提供商可能会要求您将 SD 插卡寄过去或者带过去。当得到保健服务提供商的指示后，取下 SD 插卡。

SD 指示灯闪烁时不得从装置中取出 SD 插卡。

取下 SD 插卡：

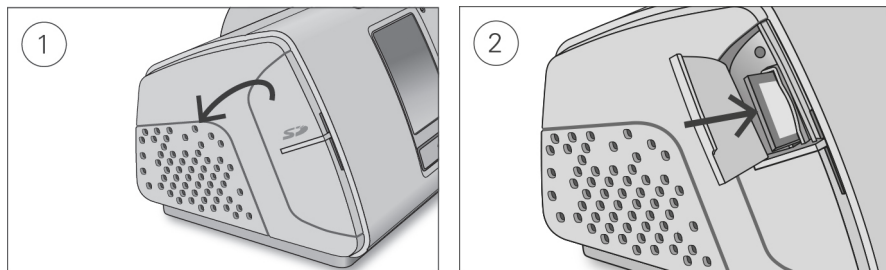

1. 打开 SD 插卡盖。
2. 推入 SD 插卡将其释放。从装置上取出 SD 插卡。  
将 SD 插卡放在保护套中，然后将它寄回给您的保健服务提供商。

欲了解更多关于 SD 插卡的信息，请参阅装置附带 SD 插卡保护套信息。

备注：SD 插卡不应用于任何其他目的。

## 旅行

无论去哪您可以随身携带您的 AirSense 10 Plus 装置。只需牢记以下几点：

- 使用提供的旅行包防止装置损坏。
- 排空加湿器并将其单独装入旅行包。
- 确保您有适合您所要旅行区域的电源线。有关购买信息，请联系您的保健服务提供商。
- 如果您使用的是外接电池，您应该关闭加湿器以使电池的寿命最大化。通过关闭湿度水平来关闭加湿器。

## 乘飞机旅行

您的 AirSense 10 Plus 装置可以作为随身行李带上飞机。医疗装置不计入您的随身行李限额。

您可以在飞机上使用您的 AirSense 10 Plus 装置，因为他符合联邦航空管理局（FAA）的要求。飞机旅行依从性的信件可以从 [www.resmed.com](http://www.resmed.com) 网站上下载打印。

在飞机上使用本装置时：

- 确保加湿器已完全排空，并插入到您的装置中。未插入加湿器的情况下该装置将不会工作。
- 打开飞行模式。



要打开飞行模式：

1. 在我的选项界面，旋转微调器以亮显飞行模式，然后按下微调器。
2. 旋转微调器以选择开启，然后按下微调器保存更改。  
飞行模式图标  显示在屏幕右上角。



## 注意

增湿器中有水时，不得在飞机上使用该装置，因为在晃动中有吸入水的危险。

## 故障排除

如果您有任何问题，可以查阅下列故障排除专题。如果您不能解决问题，请联系您的医疗服务提供方或是 ResMed。不得试图打开装置。

### 常见故障排除

问题/可能的原因	解决方案
空气从我的面罩周围泄漏出来。 面罩可能未佩戴好。	请确认面罩已佩戴好。请参阅面罩的用户指南了解佩戴的说明，或使用面罩试戴功能来检查面罩适配和密封是否良好。
我的鼻子干燥或不通。 湿度水平可能设置的太低。	调节湿度水平。 如果您有 ClimateLineAir 加热的呼吸管，参阅 ClimateLineAir 用户指南。
我的鼻子、面罩和空气管线内有水滴。 湿度水平可能设置的太高了。	调节湿度水平。 如果您有 ClimateLineAir 加热的呼吸管，参阅 ClimateLineAir 用户指南。
我的口腔干燥不适。 空气可能从您的口中溢出。	增加湿度水平。 您或许需要一个下巴托来保持您的嘴巴关闭或者是一个全脸面罩。
我面罩内的空气压力似乎太高了（感觉我吸入了太多的空气） 延迟升压可能关闭了。	使用延迟升压时间选项。
我面罩内的空气压力似乎太低了（感觉我没有吸入足够的空气） 延迟升压可能正在进行。	请等候空气压力积聚或关闭延迟升压时间。
黑屏了。 屏幕上的背景灯可能关闭了。一个短暂的时间之后，它会自动关闭。 电源可能没有连接。	按下首页或者微调器将它重新打开。 连接电源并且确保插头插入完全。

问题/可能的原因	解决方案
我已经停止治疗，但是装置仍然在输送气体。 装置正在冷却。	为了避免空气管线里的凝结，装置会吹少量的空气。 30 分钟之后它会自动停止工作。
我的增湿器漏气 增湿器可能未组装好。 增湿器可能有损坏或裂纹。	检查增湿器是否有损坏，然后重新组装好。 与您的保健服务提供商联系更换事宜。
屏幕和按钮闪烁 正在进行软件升级	软件升级大约需要 10 分钟时间完成。

## 装置信息

装置消息/可能的原因	解决方案
检测到大量漏液，请检查储水盒、储水盒密封垫或侧盖 增湿器可能未插好。 增湿器密封条可能未插好。	确保增湿器已插好。 打开增湿器，确保密封条已插好。
发现大量漏气，请连接管线。 空气管线可能连接不当。 面罩可能未佩戴好。	确认空气管线两端都已牢固连接。 请确认面罩已佩戴好。请参阅面罩的用户指南了解佩戴的说明，或使用面罩试戴功能来检查面罩适配和密封是否良好。
管路阻塞，请检查管路 空气管线可能阻塞。	检查空气管线，去除所有的阻塞。按下微调器清除该消息，然后按下开始/停止按钮以重新启动装置。
<b>SD 插卡错误</b> ，取出您的卡然后按下开始以开始治疗 SD 插卡可能未正确插入。	移除然后重新插入 SD 卡。
只读卡，请移除，解锁并重新插入 SD 插卡 SD 插卡开关可能在锁定（只读）位置。	将 SD 插卡上的开关从锁定位置  移动到解锁位置  ，然后重新插入。
系统故障，请参阅用户指南中的错误项 004 设备可能被置于过热环境。 空气过滤器可能阻塞。	待其冷却后再使用。断开电源，然后重新连接以便重启设备。 检查空气过滤器，如有阻塞则将其更换。断开电源，然后重新连接以便重启设备。

装置消息/可能的原因	解决方案
空气管线可能阻塞。	检查空气管线，去除所有的阻塞。按下微调器清除该消息，然后按下开始/停止按钮以重新启动装置。
空气管线中可能有水。	将水从空气管线中去除。断开电源，然后重新连接以便重启设备。
所有其他错误消息（例如系统故障），请参阅用户指南中的错误项 OXX	
装置上出现了一个无法恢复的错误。	请联系您的保健服务提供商。不得打开装置。

## 重新组装部件

为了避免部件或装置的损坏，装置的一些部件被设计为容易脱离。您可以根据以下描述很容易的重新组装他们。

要插入增湿器密封条：

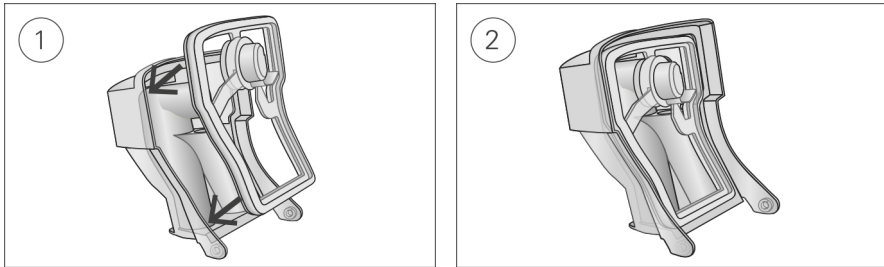

1. 将密封条放入盖内。
2. 向下按压密封条的各边缘，直至其牢固到位。

要重新组装增湿器盖：

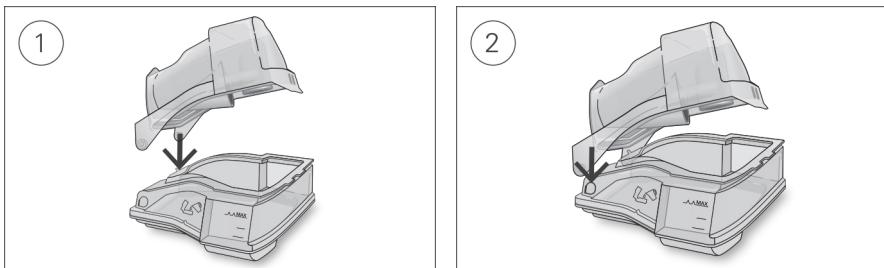

1. 将水槽盖的一边插入到底座的轴心孔内。
2. 沿边缘向下滑动另一边直至卡入到位。

## 警告

- 确保已整理好空气管线，使其不会缠绕在头或颈部周围。
- 确保电源线和插头处于良好状态，且设备无任何损坏。
- 确保电源线远离过热表面。
- 如果您发现本装置的性能发生任何无法解释的变化、装置发出异常的声音、装置或电源坠落或操作不当、或者外壳损坏，请停止使用并与您的保健服务提供商或者ResMed服务中心联系。
- 不得打开或修改装置。装置内没有用户可维修的部件。仅应由ResMed授权的维修商实施修理和维护。
- 小心触电。不得将此装置、电源或电源线浸泡在水中。如果有液体流到装置里边或者表面，拔出电源插头，使该部件晾干。在清洗前务必拔出电源插头，并在插回电源插头前确保所有部件是干燥的。
- 吸烟或者存在明火时，切勿使用补充性供氧。
- 在开启供氧之前务必确保本装置已开启并已产生气流。在关闭装置之前务必关闭供氧，使未使用的氧气不在装置外壳内积聚，造成火灾危险。
- 不得在装置工作期间执行任何保养任务。
- 在与其他设备毗邻或堆叠时，不应使用本装置。如果必须毗邻或堆叠使用，应观察装置运行情况，确保其在当前配置中运行正常。
- 除了指定用于装置的附件以外，不推荐使用其他附件。这些附件可能会增加辐射或降低本装置的抗干扰性。
- 定期检查细菌过滤器是否有水分或其他污染物的迹象，特别是在雾化或湿化过程中。否则可能导致呼吸系统阻力增加。

## 注意

- 仅使用与装置一起的ResMed部件与附件。非ResMed部件将会减少治疗的有效性和/或损坏装置。
- 仅使用由ResMed或者主治医生推荐的排气孔面罩与该装置。装置没有鼓气时面罩试戴会导致呼出的空气被再次吸入。确保面罩排气孔洞畅通无阻以便维持进入面罩的新鲜空气流量。
- 放置装置时要小心，不要放置在会使其受到碰撞或使人绊到电源线的地方。
- 装置正在运行时，如果阻塞空气管线和/或空气输入口，会导致装置过热。
- 确保装置周围区域的干燥清洁，无可能阻塞空气输入口或覆盖电源装置的任何物体（例如衣服或被褥）。
- 切勿把装置放置在旁，因为水可能会进入装置。
- 系统设定不正确可能会导致面罩压力读数不正确。确保系统设定正确。
- 不得使用漂白剂、氯、酒精或芳香类溶液、湿润或抗菌肥皂或香味精油来清洁装置、增湿器或空气管线。这些溶液可能会损坏或影响增湿器的性能，缩短产品使用寿命。
- 使用增湿器时，始终将装置放在低于头部的平面上，以免水进入面罩和空气管线。
- 在处理前，让增湿器冷却十分钟，使水冷却，以确保增湿器不会因为过热而难以触摸。
- 运输装置之前，确保增湿器已排空。

# 技术规格

单位均为 cm H<sub>2</sub>O 和 hPa。 1 cm H<sub>2</sub>O 等于 0.98 hPa。

## 90W电源装置

交流电输入范围:	100-240V, 50-60Hz 1.0-1.5A, II类 115V, 400Hz 1.5A, II类 (在飞机上使用时的标称值)
直流电输出:	24V  3.75A
典型功耗:	53W (57VA)
最大耗能:	104W (108VA)

## 环境条件

工作温度:	+5°C至+35°C 备注: 该治疗装置所产生供患者呼吸的气流温度可能会比室温高。在极端的环境温度条件下(40°C), 装置仍可保持安全。
工作湿度:	10%至95%相对湿度, 非冷凝
工作海拔高度:	海平面至2,591 公尺, 空气压力范围为1013 hPa至738 hPa。
存放和运输温度:	-20°C至+60°C
存放和运输湿度:	5%至95%相对湿度, 非冷凝

## 电磁兼容性

AirSense 10 Plus符合IEC 60601-1-2:2014标准的所有适用电磁兼容性(EMC)要求, 适用于民用、商用和轻工业环境。建议将移动通信装置与本装置保持至少1m的距离。

有关该ResMed装置电磁辐射和抗干扰性方面的信息, 请参阅[www.resmed.com/downloads/devices](http://www.resmed.com/downloads/devices)。

## 分类: IEC 60601-1:2005+A1:2012

II级(双重绝缘), BF型, IP22防护等级。

## 传感器

压力传感器:	位于装置出口内, 模拟压力型, -5至+45 cm H <sub>2</sub> O (-5至+45 hPa)
流量传感器:	位于装置出口内, 数字质量流量型, -70 至 +180 升/分

## 最大单一故障稳定状态压力

如果超过稳定状态压力, 装置会在存在一个单一故障时关机。

30 cm H<sub>2</sub>O (30 hPa)持续超过6秒或40 cm H<sub>2</sub>O (40 hPa)持续超过1秒。

## 声音

压力水平根据ISO 80601-2-70:2015 (CPAP 模式)测量:

Slimline: 25 dBA, 正负2 dBA

标准: 25 dBA, 正负2 dBA

SlimLine或标准和湿化: 27 dBA, 正负2 dBA

功率级根据ISO 80601-2-70:2015 (CPAP 模式)测量:

Slimline: 33 dBA, 正负2 dBA

标准: 33 dBA, 正负2 dBA

SlimLine或标准和湿化: 35 dBA, 正负2 dBA

声明的双数字噪音发声值符合ISO 4871:1996标准。

## 物理特征 - 装置和增湿器

尺寸(高x宽x深): 116 毫米x 255 毫米 x150 毫米

空气输出口(符合 ISO 5356-1:2004 标准): 22毫米

重量(装置和可清洁增湿器): 1208 克

机壳材料: 阻燃性工程热塑塑料

水槽容量:	至最高水位时为380毫升
可清洁增湿器 - 材料:	注塑成型塑料、不锈钢和硅胶密封条
温度	
加热板最高温度:	68°C
断开:	74°C
气体最高温度:	≤ 41°C
空气过滤器	
标准:	材料: 聚酯非织造纤维 平均计重效率 >对约7微米的尘埃为75%
低过敏性:	材料: 聚丙烯载体中的丙烯酸和聚丙烯纤维 功效: >对约7-8微米的灰尘为98%; > 对约0.5微米的灰尘为80%

#### 在飞机上使用

ResMed确认装置在空中旅行的所有阶段均满足美国联邦航空管理局(FAA)的要求 (RTCA/DO-160, 第21节, M类)。

#### 符合性声明 (R&TTE 指令符合性声明)

ResMed 声明 AirSense 10 装置符合 1999/5/EC 指令的基本要求以及其他相关规定。符合性声明 (DoC) 的副本可在 [www.ResMed.com/ProductSupport](http://www.ResMed.com/ProductSupport) 找到。

#### 工作压力范围

AutoSet、AutoSet For Her、CPAP: 4 至 20 cm H<sub>2</sub>O (4至20 hPa)

#### 补充性供氧

最大流量: 4 L/min

#### 气流量通道

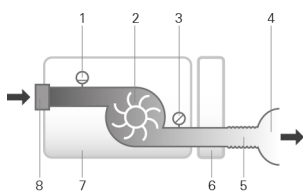

1. 流量传感器
2. 通风机
3. 压力传感器
4. 面罩
5. 空气管线
6. 增湿器
7. 装置
8. 进气口过滤器

#### 设计寿命

装置, 电源装置: 5年  
可清洁增湿器: 2.5年  
空气管线: 6个月

#### 一般信息

患者将为操作员。

#### 增湿器性能

面罩压力 cm H <sub>2</sub> O	17°C 环境温度下 RH 输出 %		22°C 环境温度下 RH 输出 %		系统标称输出 AH <sup>1</sup> , BTPS <sup>2</sup>	
	设置4	设置8	设置4	设置8	设置4	设置8
4	85	100	6		6	>10
10	85	100	6		6	>10
20	85	90	6		6	>10

<sup>1</sup> AH—绝对湿度, 以毫克/升为单位

<sup>2</sup> BTPS—饱和和压力体温

## 空气管线

空气管线	材料	长度	内径
ClimateLineAir	柔软塑料和电子元件	2 米	15 毫米
ClimateLineAir Oxy	柔软塑料和电子元件	1.9 米	19 毫米
SlimLine	柔软塑料	1.8 米	15 毫米
标准	柔软塑料	2 米	19 毫米

加热空气管线断开温度:  $\leq 41^{\circ}\text{C}$

### 备注:

- 制造商保留修改这些规格的权利, 恕不另行通知。
- 加热空气管线的电气接头端仅可以与装置端的空气输出口兼容并用, 不得连接到面罩上。
- 不得使用导电或防静电的空气管线。
- 显示的温度和相对湿度设置非测量数值。

### 显示的值

值	范围	显示分辨率
空气输出口处的压力传感器:		
面罩压力	4–20 cm H <sub>2</sub> O (4–20 hPa)	0.1 cm H <sub>2</sub> O
流量派生值:		
漏气	0 - 120 升/分	1 升/分
值	准确性	
压力测量 <sup>1</sup> :		
面罩压力 <sup>2</sup>	$\pm[0.5 \text{ cm H}_2\text{O} + \text{测量值的 } 4\%]$	
流量和流量派生值 <sup>1</sup> :		
流量	在 0 至 150 升/分正压流量时为 $\pm 6$ 升/分或读数的 10%, 取较大者	
漏气 <sup>2</sup>	在 0 至 60 升/分时为 $\pm 12$ 升/分或读数的 20%, 取较大者	

<sup>1</sup> 结果在 STPD (干燥标准气温和气压) 的情况下表示。

<sup>2</sup> 准确性可能因为存在漏气、补充性供氧、潮气量 < 100 mL 或分钟通气量 < 3 升/分而降低。

### 测量系统不确定性

依照 ISO 80601-2-70:2015, 制造商的测试设备的测量不确定性为:

对于流量测量值	$\pm 1.5$ 升/分或读数的 2.7%(取较大者)
对于容积测量值 (< 100 毫升)	$\pm 5$ 毫升或读数的 6% (取较大者)
对于容积测量值 ( $\geq 100$ 毫升)	$\pm 20$ 毫升或读数的 3% (取较大者)
对于压力测量值	$\pm 0.15 \text{ cm H}_2\text{O}$ (0.15 hPa)
对于时间测量值	$\pm 10$ 毫秒

### 压力准确性

根据ISO 80601-2-70:2015标准, 在10 cm H<sub>2</sub>O 条件下的最大静态压力变化

	标准空气管线	SlimLine 空气管线
不使用湿化	$\pm 0.5 \text{ cm H}_2\text{O}$	$\pm 0.5 \text{ cm H}_2\text{O}$
使用湿化	$\pm 0.5 \text{ cm H}_2\text{O}$	$\pm 0.5 \text{ cm H}_2\text{O}$

根据 ISO 80601-2-70:2015 标准的最大动态压力变化

不使用湿化和标准空气管线的装置/使用湿化和标准空气管线的装置

压力[cm H <sub>2</sub> O]	10 BPM	15 BPM	20 BPM
4	0.5 / 0.5	0.5 / 0.5	0.8 / 0.8
8	0.5 / 0.5	0.5 / 0.5	0.8 / 0.8
12	0.5 / 0.5	0.5 / 0.5	0.8 / 0.8
16	0.5 / 0.5	0.5 / 0.5	0.8 / 0.8
20	0.5 / 0.5	0.5 / 0.5	0.8 / 0.8

不使用湿化和 SlimLine 空气管线的装置/使用湿化和 SlimLine 空气管线的装置

压力[cm H <sub>2</sub> O]	10 BPM	15 BPM	20 BPM
4	0.5 / 0.5	0.5 / 0.5	0.8 / 0.8
8	0.5 / 0.5	0.5 / 0.5	0.8 / 0.8
12	0.5 / 0.5	0.5 / 0.5	0.8 / 0.8
16	0.5 / 0.5	0.5 / 0.5	0.8 / 0.8
20	0.5 / 0.5	0.5 / 0.5	0.8 / 0.8



























设定压力下的流量（最大）

在指定空气管线的末端，按照 ISO 80601-2-70:2015 标准测量以下各项：

压力 cm H <sub>2</sub> O	AirSense 10 Plus 和标准 升/分	AirSense 10 Plus, 湿化和标准 升/分	AirSense 10 Plus 和 SlimLine 升/分	AirSense 10 Plus, 湿 化和 ClimateLineAir 升/分
4	180	143	162	151
8	168	135	151	142
12	157	136	140	135
16	144	134	128	121
20	131	123	117	109

## 符号

以下符号可能出现在产品或包装上。

 使用前阅读说明。
  指示警告或注意。
  使用前遵循说明。
  制造商。
  欧洲授权代表。
  批代码。
  目录号。
  序列号。
  装置号。
  开启 / 关闭。
  装置重量
 IP22 当向指定方向倾斜 15 度时，防止手指大小的物体和滴水进入。
  直流电。
  BF
  型应用部件。
  类设备。
  湿度限制。
  温度限制。
  无电离辐射
  中国标志，产品不含有害物质。
  中国标志，产品环保使用期限 10/20 年。
  Rx Only 仅凭处方销售（在美国，联邦法律规定这些装置只能由医生出售或遵照医嘱销售。）
  MAX 最高水位。
  仅使用蒸馏水。
  工作海拔高度。
  大气压限制。
  符合 RTCA DO-160 第 21 部分类别 M。





## 环保信息

此装置需单独处置，不得作为不分类的市政废物处置。处置该装置时应使用所在地区的适当收集、再利用和回收系统。按其设计，这些收集、再利用和回收系统可以减少对自然资源的危害，防止危险物质破坏环境。

如果需要了解有关这些处置系统的详细信息，请与所在地的废物管理部门联系。标有十字的垃圾筒标志表示您可使用这些处置系统。要了解有关 ResMed 装置的回收和处置信息，请与 ResMed 办事处或当地的经销商联系，或浏览以下网站：[www.resmed.com/environment](http://www.resmed.com/environment)。

## 维修

按照 ResMed 提供的说明操作时，AirSense 10 Plus 装置将会提供安全可靠的运行。如果 AirSense 10 Plus 装置有磨损现象或者您对装置的功能有任何顾虑，ResMed 建议应由授权的 ResMed 服务中心进行检查和维修。否则，在设计使用寿命期间，产品通常不需要进行保养和检查。

## 有限保修

ResMed 有限公司（以下简称“ResMed”）保证，自购买日算起，在以下规定的期间内，您购买的 ResMed 产品没有材料和制造工艺方面的缺陷。

产品	保修期
<ul style="list-style-type: none"> <li>面罩系统（包括面罩框架、护垫、头带和管线） - 不包括一次性使用装置</li> <li>配件 - 不包括一次性使用装置</li> <li>柔性手指脉搏传感器</li> <li>湿化器水槽</li> </ul>	90 天
<ul style="list-style-type: none"> <li>ResMed 内外电池系统使用的电池</li> </ul>	6个月
<ul style="list-style-type: none"> <li>夹式手指脉搏传感器</li> <li>CPAP 和双水平装置数据模块</li> <li>血氧仪和 CPAP 和双水平装置血氧仪适配器</li> <li>增湿器及增湿器可清洗湿化器水槽</li> <li>滴定式控制装置</li> </ul>	1年
<ul style="list-style-type: none"> <li>CPAP、双水平装置和通气装置（包括外部供电装置）</li> <li>电池配件</li> <li>便携式诊断/筛查装置</li> </ul>	2年

该保修只适用于最初消费者。不得转让。

如果在正常使用下产品出现故障，ResMed 将根据其具体选择对有缺陷的产品或任何元件予以修理或更换。

此有限保修不包括：a)使用不当、滥用、改装或修改产品所造成的任何损坏；b)由未获得ResMed明确维修授权的任何维修机构实施的该项维修工作；c)香烟、烟斗、雪茄或其它烟雾造成的任何损坏或污染；d)由于水溢在电子装置上或电子装置内所造成的任何损坏。

如果产品被在最初购买地区以外销售或再销售，此保修则无效。

必须由原始消费者在购买处对有缺陷产品提出保修声明。

此保修代替所有其它明示或暗示的保修，其中包括对产品适销性或某特定用途适用性的任何暗示保修。某些国家/地区不允许限制暗示保修的时间期限，因此以上限制也许不适用于您。

对于那些声称由于销售、安装或使用任何 ResMed 产品所造成的任何偶然性或因果性损失，ResMed 概不负责。某些地区或州/省不允许排除或限制偶然性或因果性损失，因此以上限制也许不适用于您。本保修授予您某些特定合法权利，您可能还有不同地区规定的其它权利。有关保修权利的详细信息，请与当地的 ResMed 分销商或 ResMed 办事处联系。

## 补充信息

如果您有任何问题或需要关于如何使用本装置的更多信息，请联系您的保健服务提供商。



**ResMed Pty Ltd**

**MANUFACTURER** 1 Elizabeth Macarthur Drive Bella Vista NSW 2153 Australia

See [www.resmed.com](http://www.resmed.com) for other ResMed locations worldwide. For patent information, see [www.resmed.com/ip](http://www.resmed.com/ip). Air10, AirSense, AutoSet, ClimateLine, HumidAir and SlimLine are trademarks and/or registered trademarks of the ResMed family of companies. SD Logo is a trademark of SD-3C, LLC.  
© 2020 ResMed. 378946/1 2020-11

[ResMed.com](http://ResMed.com)



378946